

Typical unit

FEATURES

- 600 KHz operation
- 4.5-14 Vdc input voltage range
- Programmable output voltage from 0.591-6.0 VDC
- High power conversion efficiency at 93%
- Outstanding thermal derating performance
- Over temperature and over current protection
- On/Off control
- SIP, 0.41 x 0.40 x 0.24 inches (10.4 x 10.16 x 6.1 mm)
- Certified to UL/EN/IEC 60950-1 safety standards, 2nd edition
- RoHS-6 hazardous substance compliance

PRODUCT OVERVIEW

The OKR-T/1.5-W12-C is a miniature SIP non-isolated Point-of-Load (PoL) DC/DC power converter measuring only 0.41 x 0.40 x 0.24 inches (10.4 x 10.16 x 6.1 mm). The wide input range is 4.5 to 14 Volts DC. Based on 600 KHz synchronous buck topology, the high power conversion efficient Point of Load (PoL) module features programmable output voltage and On/Off control, under voltage lock out (UVLO), overcurrent and over temperature protections. These units are certified to UL/EN/ IEC 60950-1 safety standards (2nd edition) and RoHS-6 hazardous substance compliance.

Figure 1. Connection Diagram

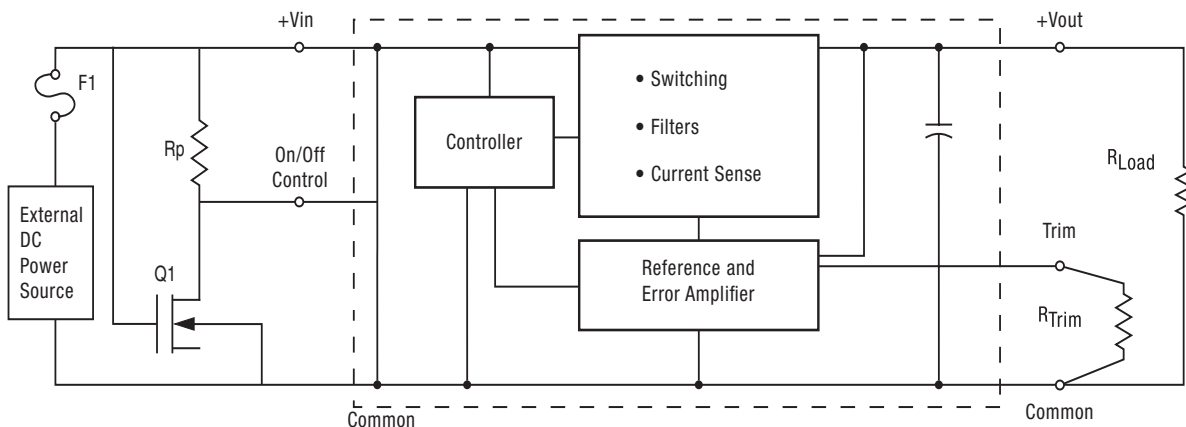

PERFORMANCE SPECIFICATIONS SUMMARY AND ORDERING GUIDE													
Root Model	Output						Input				Efficiency		Dimensions (Inches)
	V _{out} (Volts)	I _{out} (Amps max)	Power (Watts)	R/N (mVp-p)	Regulation (Max.)		V _{in} Nom. (Volts)	Range (Volts)	I _{in} , no load (mA)	I _{in} , full load (Amps)	Efficiency		
				Max.	Line	Load					Min.	Typ.	
OKR-T/1.5-W12-C	0.591-6	1.5	7.5	25	±0.3%	±0.5%	12	4.5-14	80	0.672	91%	93%	0.41x0.40x0.24

① The input voltage range must be +2V greater for the 3.3V and 5V outputs.

③ Ripple and Noise (R/N) is shown at V_{out}=1V. See specs for details.

② All specifications are at nominal line voltage, V_{out}=nominal (5V for W12 models) and full load, +25°C unless otherwise noted.

PART NUMBER STRUCTURE

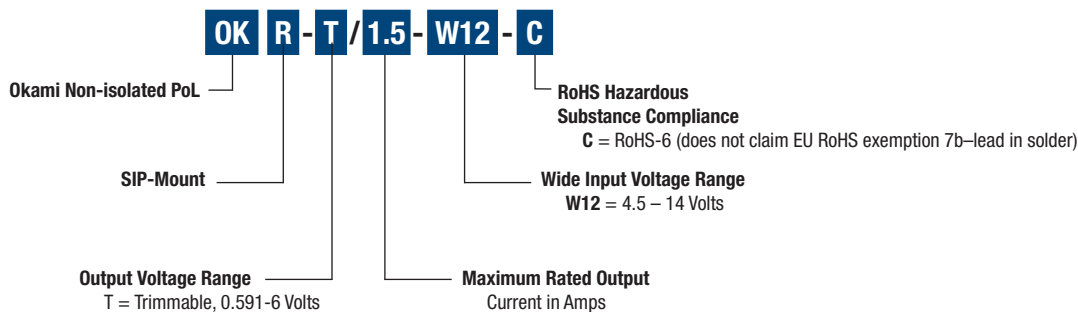

Product Label

Because of the small size of these products, the product label contains a character-reduced code to indicate the model number and manufacturing date code. Not all items on the label are always used. Please note that the label differs from the product photograph on page 1. Here is the layout of the label:

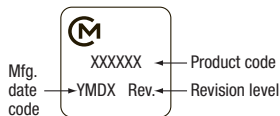

Figure 2. Label Artwork Layout

The label contains three rows of information:

- First row – Murata Power Solutions logo
- Second row – Model number product code (see table)
- Third row – Manufacturing date code and revision level

Model Number	Product Code
OKR-T/1.5-W12-C	54733

The manufacturing date code is four characters:

- First character – Last digit of manufacturing year, example 2009
- Second character – Month code (1 through 9 = Jan-Sep; 0, N, D = Oct, Nov, Dec)
- Third character – Day code (1 through 9 = 1 to 9, 10 = 0 and 11 through 31 = A through Z)
- Fourth character – Manufacturing information

FUNCTIONAL SPECIFICATIONS

ABSOLUTE MAXIMUM RATINGS	Conditions ①	Minimum	Typical/Nominal	Maximum	Units
Input Voltage, Continuous	Full power operation	0		15	Vdc
Input Reverse Polarity	None, install external fuse		None		Vdc
On/Off Remote Control	Power on or off, referred to -Vin	0		14	Vdc
Output Power		0	7.5	7.65	W
Output Current	Current-limited, no damage, short-circuit protected	0		1.5	A
Storage Temperature Range	Vin = Zero (no power)	-55		125	°C
Absolute maximums are stress ratings. Exposure of devices to greater than any of these conditions may adversely affect long-term reliability. Proper operation under conditions other than those listed in the Performance/Functional Specifications Table is not implied or recommended.					
INPUT					
Operating voltage range	Vin ≥ Vout + 2V for 3.3V and 5V	4.5	12	14	Vdc
Recommended External Fuse	Fast blow			3	A
Turn On/Start-up threshold	Rising input voltage	3.9	4.2	4.4	Vdc
Turn Off/Undervoltage lockout ③	Falling input voltage	3	3.4	3.7	Vdc
Reverse Polarity Protection	None, install external fuse		None		Vdc
Internal Filter Type			C-TYPE		
Input current					
Full Load Conditions	Vin = nominal (5Vo set)		0.672	0.701	A
Low Line	Vin @ min, 5 Vout		1.122	1.163	A
Inrush Transient			0.4		A ² -Sec.
Short Circuit Input Current			60		mA
No Load Input Current	5Vout, Iout @ 0		80	100	mA
No Load Input Current	0.59V, Iout @ 0		40	55	mA
Shut-Down Mode Input Current			5		mA
Reflected (back) ripple current ②	Measured at input with specified filter		20		mA, pk-pk
GENERAL and SAFETY					
Efficiency	@ Vin nom, 5Vout	91	93		%
	@ Vin min, 5Vout	94	95.5		%
	@ Vin nom, 3.3Vout	88.5	90		%
	@ Vin nom, 2.5Vout	86	88		%
	@ Vin nom, 1.8Vout	82.5	84.5		%
	@ Vin nom, 1.5Vout	80	82.5		%
	@ Vin nom, 1.2Vout	77	79		%
	@ Vin nom, 1Vout	74	76		%
Safety	Certified to UL-60950-1, IEC/EN60950-1, 2nd Edition		Yes		
Calculated MTBF ④	Per Telcordia SR332, issue 1, class 3, ground fixed, Tambient = +25°C		10.7		Hours x 10 ⁶
DYNAMIC CHARACTERISTICS					
Fixed Switching Frequency			600		KHz
Startup Time	Power On to Vout regulated (100% resistive load)		6		mS
Startup Time	Remote ON to 10% Vout (50% resistive load)		6	8	mS
Dynamic Load Response	50-100-50% load step, settling time to within ±2% of Vout di/dt = 2.5 A/μSec		50	100	μSec
Dynamic Load Peak Deviation	same as above		100	200	mV
FEATURES and OPTIONS					
Remote On/Off Control ⑤					
"P" suffix: a 49.2KΩ pulldown to ground needed.					
Positive Logic, ON state	Pin open=ON	2		+Vin	V
Positive Logic, OFF state		0		0.2	V
Control Current	open collector/drain		1		mA

FUNCTIONAL SPECIFICATIONS (CONT.)

OUTPUT	Conditions ①	Minimum	Typical/Nominal	Maximum	Units
Total Output Power		0	7.5	7.65	W
Voltage					
Nominal Output Voltage Range ③	See trim formula	0.591		6	Vdc
Setting Accuracy	At 50% load	-2		2	% of Vnom.
Output Voltage Overshoot - Startup:				1	%Vo nom
Current					
Output Current Range		0	1.5	1.5	A
Minimum Load			No minimum load		
Current Limit Inception ⑥	98% of Vnom., after warmup @5Vout	2.65	4.15	5.15	A
Short Circuit					
Short Circuit Current ⑦	Hiccup technique, autorecovery within ±1% of Vout		0.6		A
Short Circuit Duration (remove short for recovery)	Output shorted to ground, no damage		Continuous		
Short circuit protection method	Current limiting				
Regulation ⑩					
Total Regulation Band	Over all line, load and temp conditions	-3	Vo set	3	% Vo set
Line Regulation	Vin=min. to max. Vout=nom.			±0.3	%
Load Regulation	Iout=min. to max. Vin=48V.			±0.5	%
Ripple and Noise ⑧	5Vo, 12Vin			75	mV pk-pk
	3.3Vo, 12Vin			60	mV pk-pk
	1.8Vo, 12Vin			40	mV pk-pk
	1Vo, 12Vin			25	mV pk-pk
Temperature Coefficient	At all outputs		±0.02		% of Vnom./°C
Maximum Capacitive Loading ④	low ESR; >0.001, <0.01 ohm		200		µF
Maximum Capacitive Loading	0.01 ohm		1000		µF
MECHANICAL					
Outline Dimensions			0.41x0.40x0.24		Inches
			10.4x10.2x6.1		mm
Weight			0.07		Ounces
			2		Grams
Pin Material			copper alloy		
Pin Finish	Tin		2.54-7.62		µm
	Nickel		1.9-3.81		µm
ENVIRONMENTAL					
Operating Ambient Temperature Range ⑨	full power, all output voltages, see derating curves	-40		85	°C
Operating PCB Temperature ⑩	No derating	-40		100	°C
Storage Temperature	Vin = Zero (no power)	-55		125	°C
Thermal Protection/Shutdown	Measured in center	130	130	135	°C

Notes:

- ① Specifications are typical at +25 deg.C, Vin=nominal (+12V), Vout=nominal (+5V), full load, external caps and natural convection unless otherwise indicated. Extended tests at higher power must supply substantial forced airflow. All models are tested and specified with external 1 µF paralleled with 10 µF ceramic output capacitors and a 22 µF external input capacitor. All capacitors are low ESR types. These capacitors are necessary to accommodate our test equipment and may not be required to achieve specified performance in your applications. However, Murata Power Solutions recommends installation of these capacitors. All models are stable and regulate within spec under no-load conditions.
- ② Input Back Ripple Current is tested and specified over a 5 Hz to 20 MHz bandwidth. Input filtering is Cin=2 x 100 µF tantalum, Cbus=1000 µF electrolytic, Lbus=1 µH.
- ③ Note that Maximum Power Derating curves indicate an average current at nominal input voltage. At higher temperatures and/or lower airflow, the DC/DC converter will tolerate brief full current outputs if the total RMS current over time does not exceed the Derating curve.
- ④ Mean Time Before Failure is calculated using the Telcordia (Belcore) SR-332 Method 1, Case 3, ISSUE 2, ground fixed controlled conditions, Tambient=+25 deg.C, full output load, natural air convection.
- ⑤ The On/Off Control Input should use either a switch or an open collector/open drain transistor referenced to -Input Common. A logic gate may also be used by applying appropriate external voltages which not exceed +Vin.
- ⑥ Short circuit shutdown begins when the output voltage degrades approximately 1% from the selected setting.
- ⑦ "Hiccup" overcurrent operation repeatedly attempts to restart the converter with a brief, full-current output. If the overcurrent condition still exists, the restart current will be removed and then tried again. This short current pulse prevents overheating and damaging the converter. Once the fault is removed, the converter immediately recovers normal operation.
- ⑧ Output noise may be further reduced by adding an external filter. At zero output current, the output may contain low frequency components which exceed the ripple specification. The output may be operated indefinitely with no load.
- ⑨ All models are fully operational and meet published specifications, including "cold start" at -40°C.
- ⑩ Regulation specifications describe the deviation as the line input voltage or output load current is varied from a nominal midpoint value to either extreme.
- ⑪ Other input or output voltage ranges will be reviewed under scheduled quantity special order.
- ⑫ Maximum PC board temperature is measured with the sensor in the center of the converter.
- ⑬ Do not exceed maximum power specifications when adjusting the output trim.
- ⑭ The maximum output capacitive loads depend on the the Equivalent Series Resistance (ESR) of the external output capacitor and, to a lesser extent, the distance and series impedance to the load. Larger caps will reduce output noise but may change the transient response. Newer ceramic caps with very low ESR may require lower capacitor values to avoid instability. Thoroughly test your capacitors in the application. Please refer to the Output Capacitive Load Application Note.
- ⑮ Do not allow the input voltage to degrade lower than the input undervoltage shutdown voltage at all times. Otherwise, you risk having the converter turn off. The undervoltage shutdown is not latching and will attempt to recover when the input is brought back into normal operating range.
- ⑯ The outputs are not intended to sink appreciable reverse current.

OKR-T/1.5-W12-C PERFORMANCE DATA

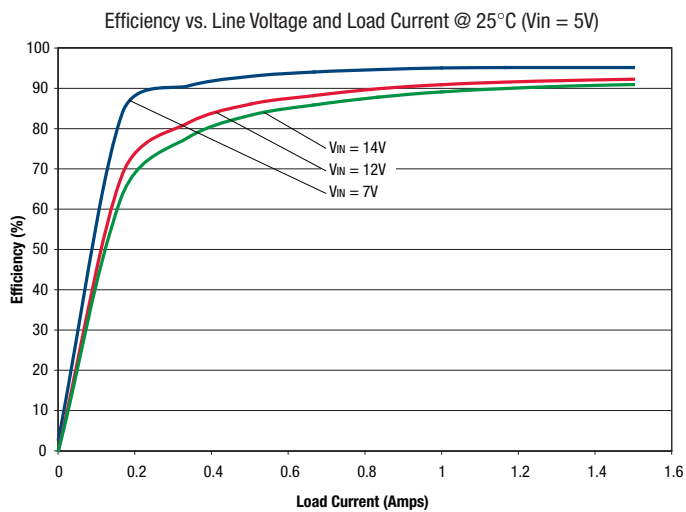
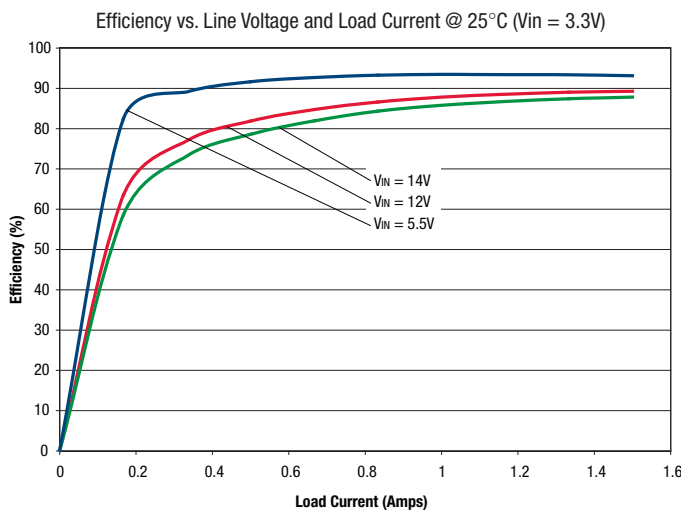
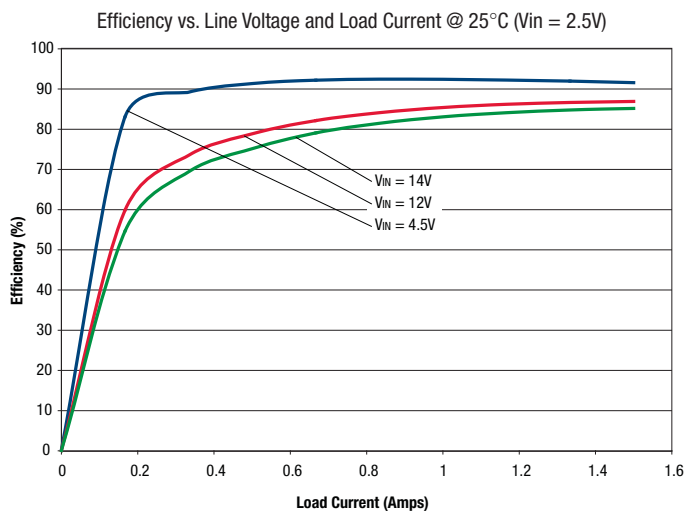
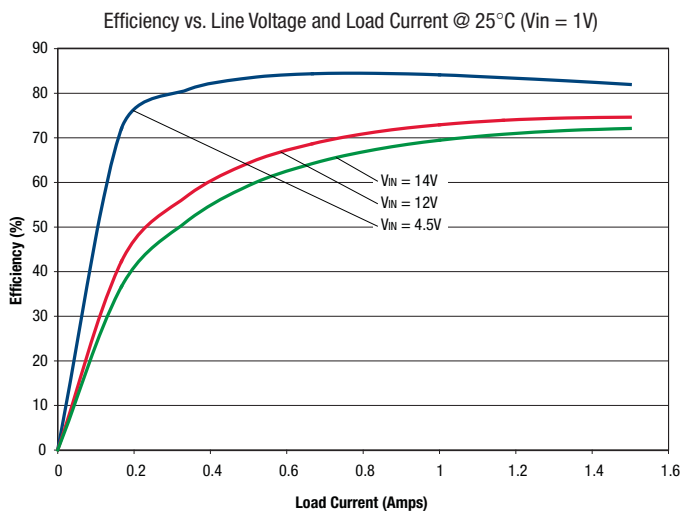

OKR-T/1.5-W12-C OSCILLOGRAMS

On/Off Enable Startup (Vin=12V, Vout=1.5V, Iout=1.5A, Clod=0)
Channel 2=Enable, Channel 1=Vout

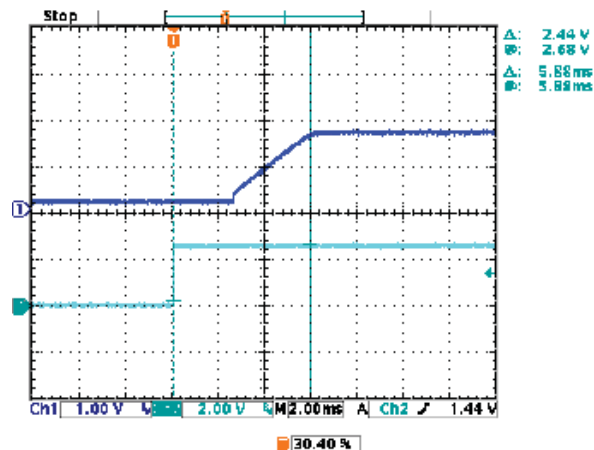

Maximum Current Temperature Derating @ Sea Level
(Vin = 7V and 12V, Vout = 5V and 6 V)

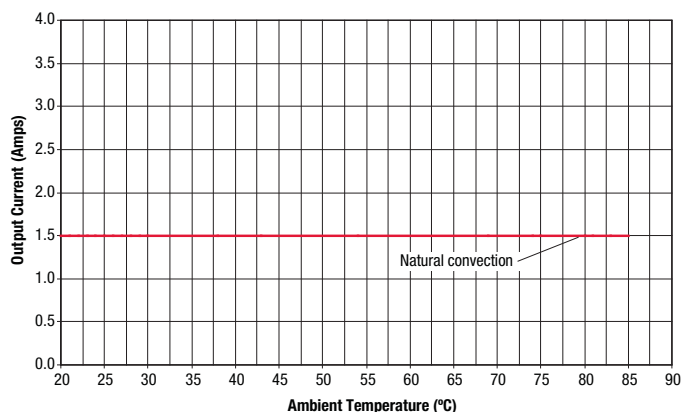

There is no derating for Vout = 0.591V. to 5.5V. at full load.

OKR-T/1.5-W12-C OSCILLOGRAMS – Vout = 1.8V

Step Load Transient Response (Vin=12V, Vout=1.8V, Cload=5x10µF
X5R 0805 ceramic, total 50µF, Iout=0A to 1.5A) Top trace=Vout, Bottom trace=Iout

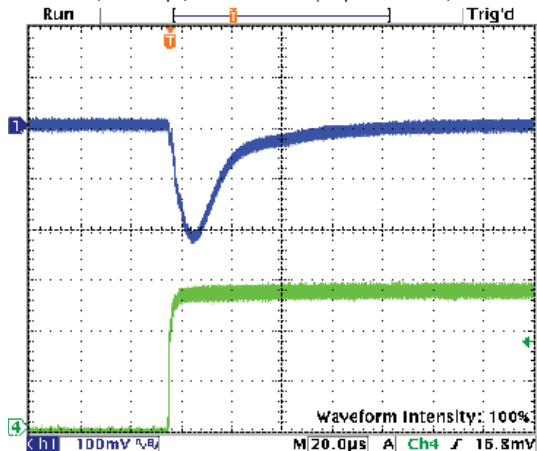

Step Load Transient Response (Vin=12V, Vout=1.8V, Cload=5x10µF
X5R 0805 ceramic, total 50µF, Iout=1.5A to 0A) Top trace=Vout, Bottom trace=Iout

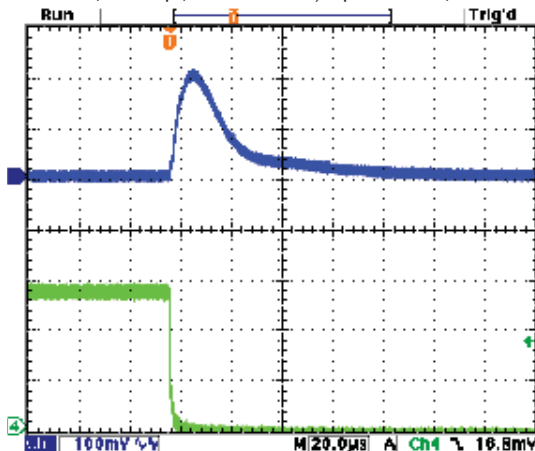

Step Load Transient Response (Vin=4.5V, Vout=1.8V, Cload=5x10µF
X5R 0805 ceramic, total 50µF, Iout=0A to 1.5A) Top trace=Vout, Bottom trace=Iout

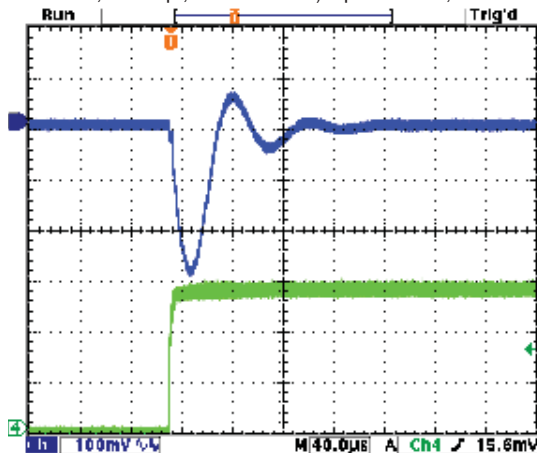

Step Load Transient Response (Vin=4.5V, Vout=1.8V, Cload=5x10µF
X5R 0805 ceramic, total 50µF, Iout=1.5A to 0A) Top trace=Vout, Bottom trace=Iout

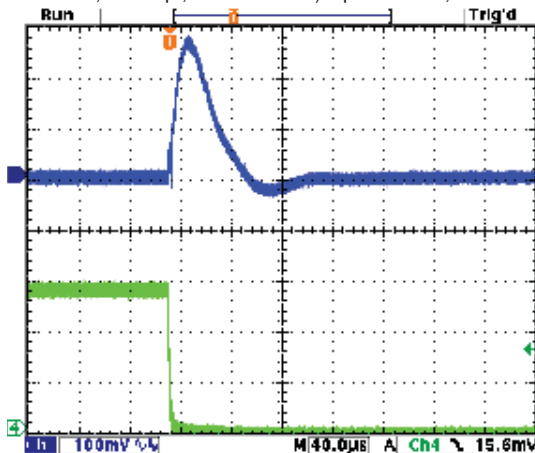

Step Load Transient Response (Vin=12V, Vout=1.8V, Cload=12x10µF
X5R 0805 ceramic, total 120µF, Iout=0A to 1.5A) Top trace=Vout, Bottom trace=Iout

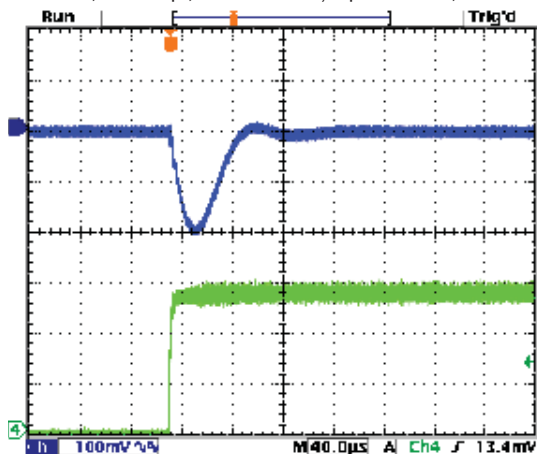

Step Load Transient Response (Vin=12V, Vout=1.8V, Cload=12x10µF
X5R 0805 ceramic, total 120µF, Iout=1.5A to 0A) Top trace=Vout, Bottom trace=Iout

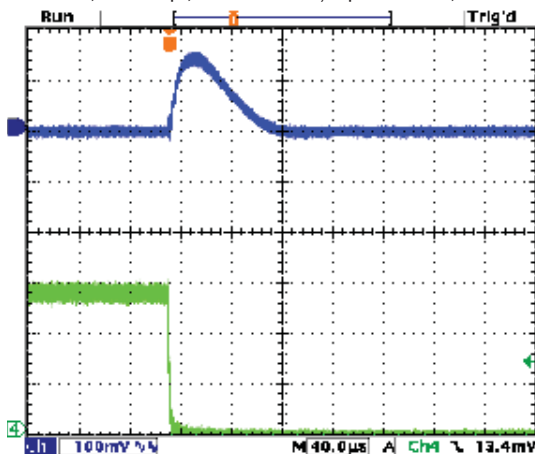

OKR-T/1.5-W12-C OSCILLOGRAMS – Vout = 1.8V

Step Load Transient Response (Vin=4.5V, Vout=1.8V, Cload=12x10µF X5R 0805 ceramic, total 120µF, Iout=0A to 1.5A) Top trace=Vout, Bottom trace=Iout

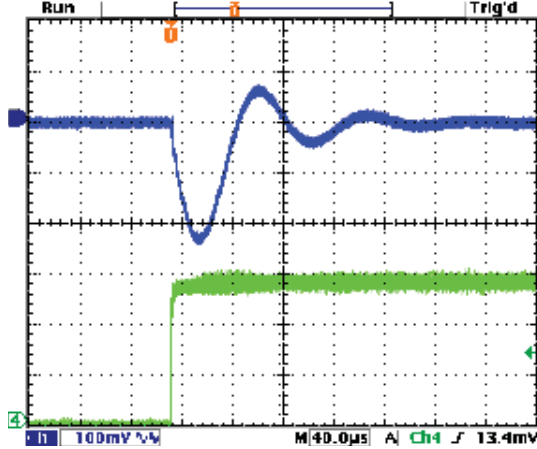

Step Load Transient Response (Vin=4.5V, Vout=1.8V, Cload=12x10µF X5R 0805 ceramic, total 120µF, Iout=1.5A to 0A) Top trace=Vout, Bottom trace=Iout

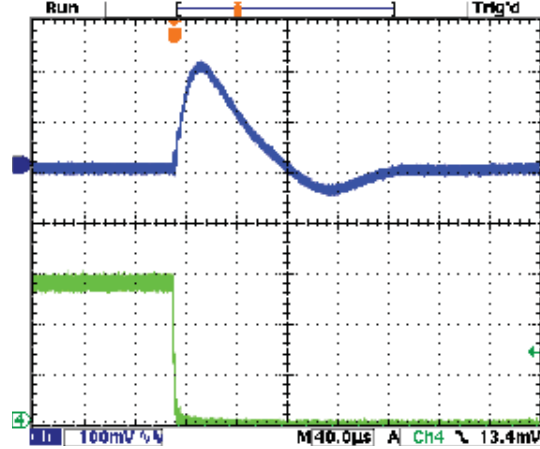

Step Load Transient Response (Vin=4.5V, Vout=1.8V, Cload=10x10µF X5R 0805 ceramic, plus 1x470µF, 7mΩ POSCAP, total 570µF, Iout=0A to 1.5A) Top trace=Vout, Bottom trace=Iout

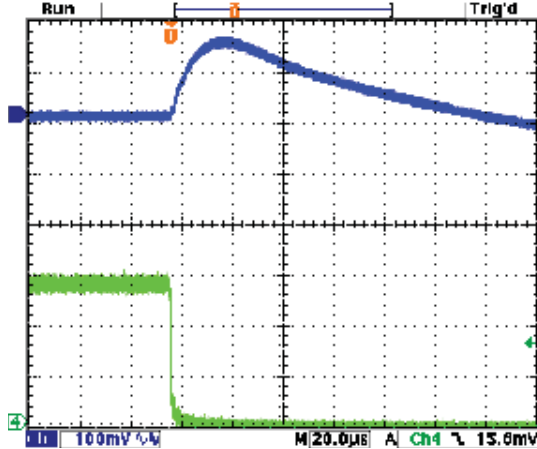

Step Load Transient Response (Vin=4.5V, Vout=1.8V, Cload=10x10µF X5R 0805 ceramic, plus 1x470µF, 7mΩ POSCAP, total 570µF, Iout=1.5A to 0A) Top trace=Vout, Bottom trace=Iout

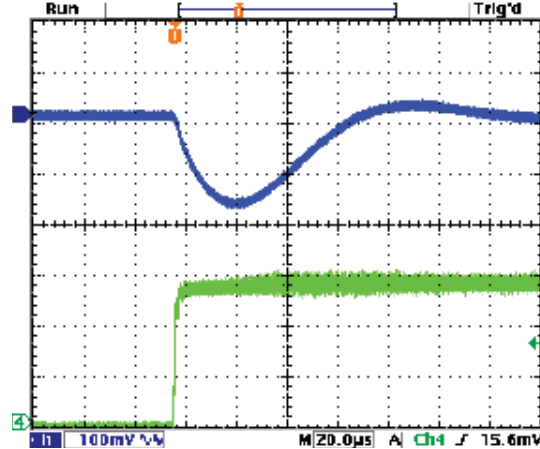

Step Load Transient Response (Vin=12V, Vout=1.8V, Cload=10x10µF X5R 0805 ceramic, plus 1x470µF, 7mΩ POSCAP, total 570µF, Iout=0A to 1.5A) Top trace=Vout, Bottom trace=Iout

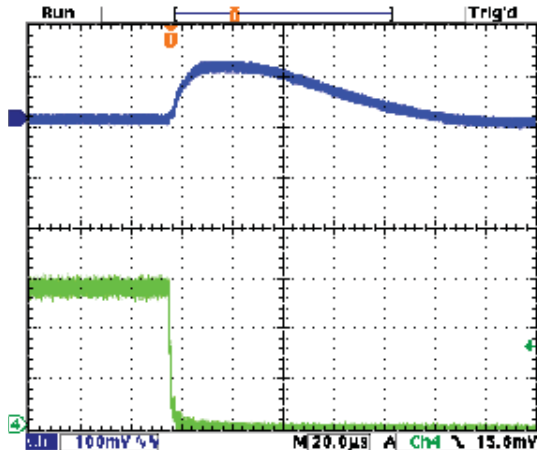

Step Load Transient Response (Vin=12V, Vout=1.8V, Cload=10x10µF X5R 0805 ceramic, plus 1x470µF, 7mΩ POSCAP, total 570µF, Iout=1.5A to 0A) Top trace=Vout, Bottom trace=Iout

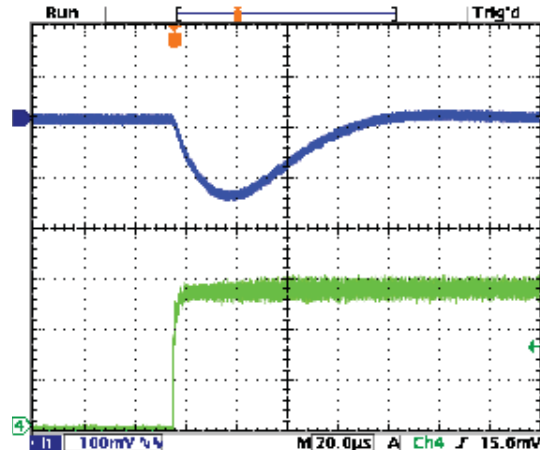

OKR-T/1.5-W12-C OSCILLOGRAMS – Vout = 3.3V

Step Load Transient Response (Vin=12V, Vout=3.3V, Cload=5x10µF
X5R 0805 ceramic, total 50µF, Iout=0A to 1.5A) Top trace=Vout, Bottom trace=Iout

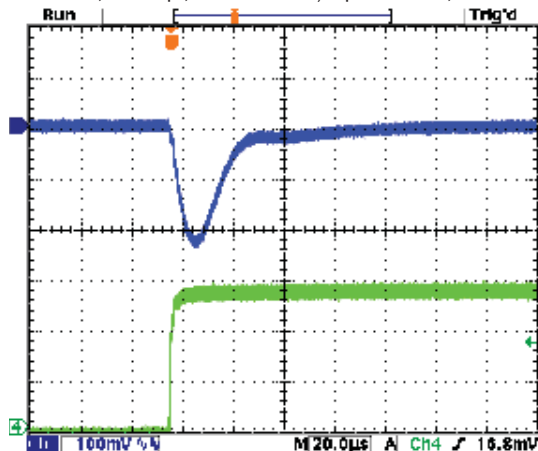

Step Load Transient Response (Vin=12V, Vout=3.3V, Cload=5x10µF
X5R 0805 ceramic, total 50µF, Iout=1.5A to 0A) Top trace=Vout, Bottom trace=Iout

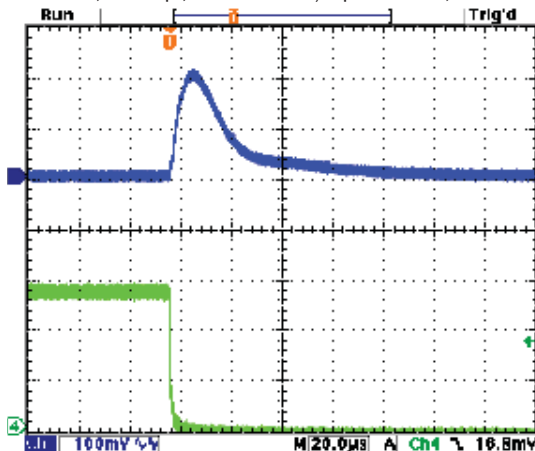

Step Load Transient Response (Vin=5.5V, Vout=3.3V, Cload=5x10µF
X5R 0805 ceramic, total 50µF, Iout=0A to 1.5A) Top trace=Vout, Bottom trace=Iout

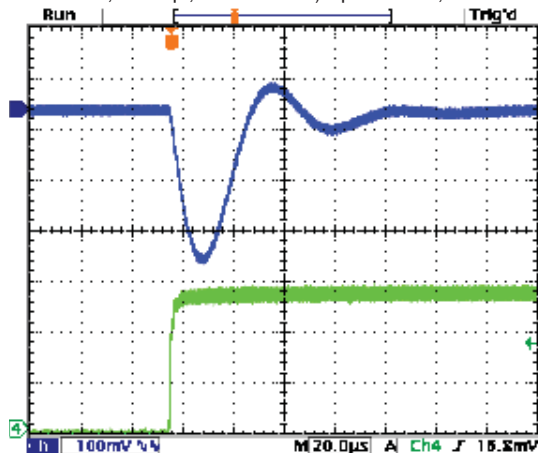

Step Load Transient Response (Vin=5.5V, Vout=3.3V, Cload=5x10µF
X5R 0805 ceramic, total 50µF, Iout=1.5A to 0A) Top trace=Vout, Bottom trace=Iout

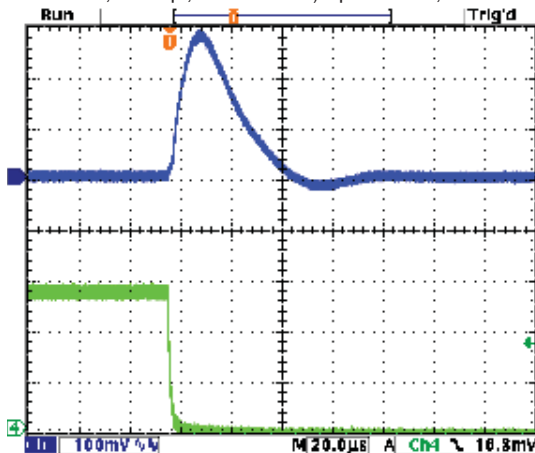

Step Load Transient Response (Vin=12V, Vout=3.3V, Cload=12x10µF
X5R 0805 ceramic, total 120µF, Iout=0A to 1.5A) Top trace=Vout, Bottom trace=Iout

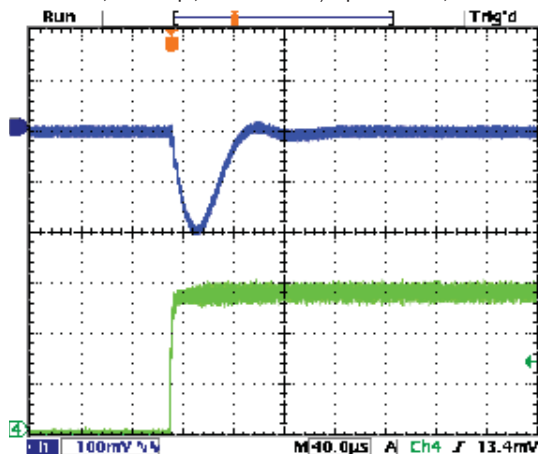

Step Load Transient Response (Vin=12V, Vout=3.3V, Cload=12x10µF
X5R 0805 ceramic, total 120µF, Iout=1.5A to 0A) Top trace=Vout, Bottom trace=Iout

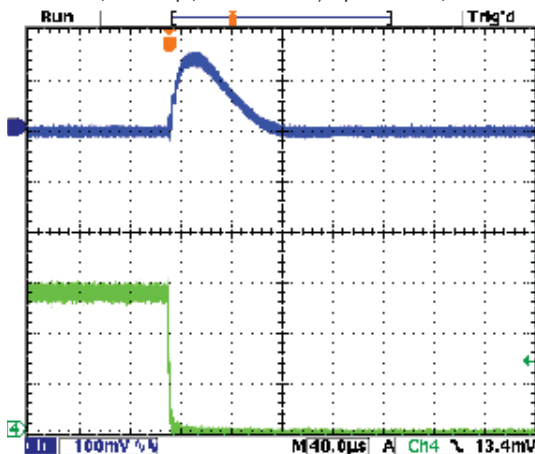

OKR-T/1.5-W12-C OSCILLOGRAMS – Vout = 3.3V

Step Load Transient Response (Vin=5.5V, Vout=3.3V, Cload=12x10µF X5R 0805 ceramic, total 120µF, Iout=0A to 1.5A) Top trace=Vout, Bottom trace=Iout

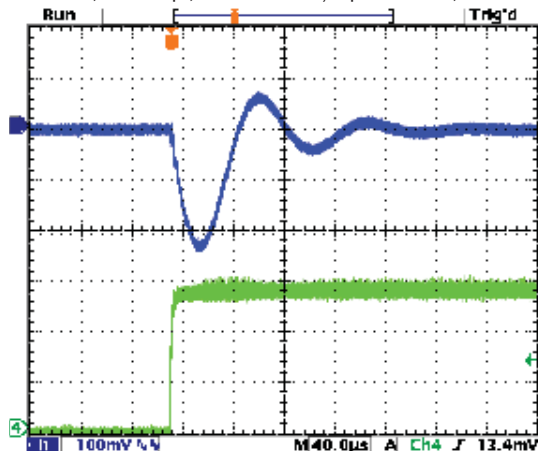

Step Load Transient Response (Vin=5.5V, Vout=3.3V, Cload=12x10µF X5R 0805 ceramic, total 120µF, Iout=1.5A to 0A) Top trace=Vout, Bottom trace=Iout

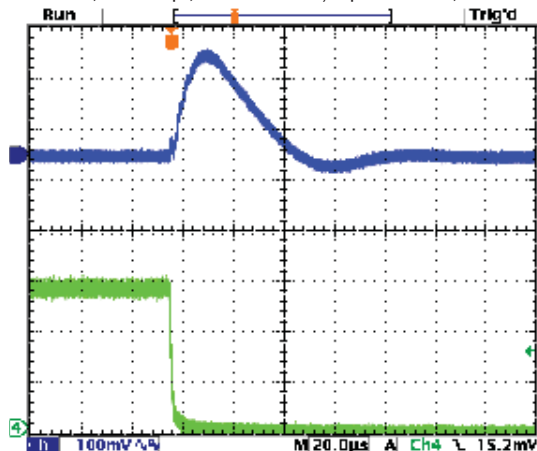

Step Load Transient Response (Vin=5.5V, Vout=3.3V, Cload=10x10µF X5R 0805 ceramic, plus 1x470µF, 7mΩ POSCAP, total 570µF, Iout=0A to 1.5A) Top trace=Vout, Bottom trace=Iout

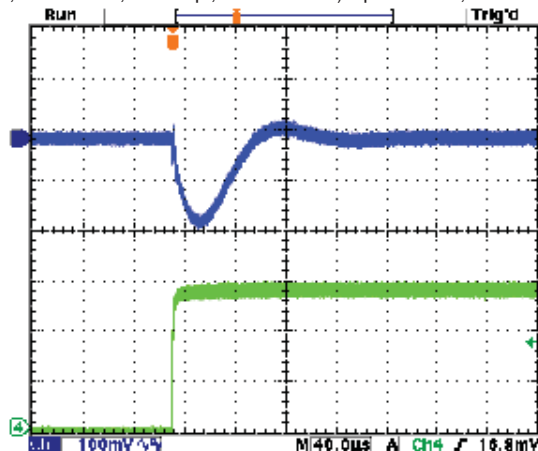

Step Load Transient Response (Vin=5.5V, Vout=3.3V, Cload=10x10µF X5R 0805 ceramic, plus 1x470µF, 7mΩ POSCAP, total 570µF, Iout=1.5A to 0A) Top trace=Vout, Bottom trace=Iout

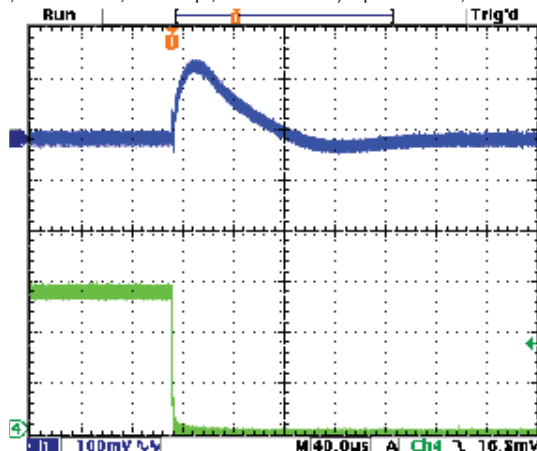

Step Load Transient Response (Vin=12V, Vout=3.3V, Cload=10x10µF X5R 0805 ceramic, plus 1x470µF, 7mΩ POSCAP, total 570µF, Iout=0A to 1.5A) Top trace=Vout, Bottom trace=Iout

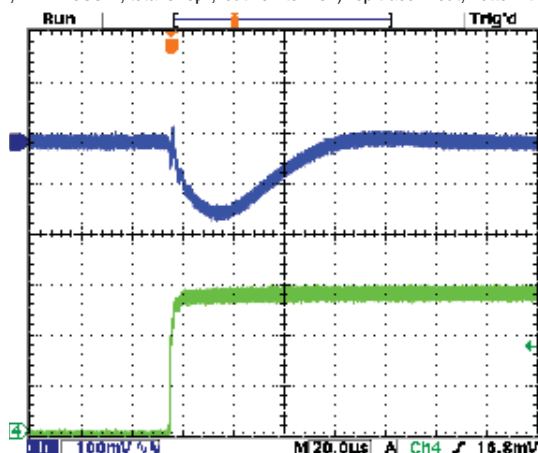

Step Load Transient Response (Vin=12V, Vout=3.3V, Cload=10x10µF 5R 0805 ceramic, plus 1x470µF, 7mΩ POSCAP, total 570µF, Iout=1.5A to 0A) Top trace=Vout, Bottom trace=Iout

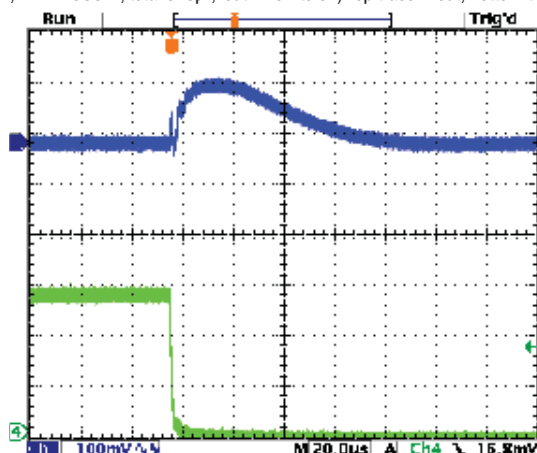

OKR-T/1.5-W12-C OSCILLOGRAMS – Vout = 5V

Step Load Transient Response (Vin=12V, Vout=5V, Cload=5x10µF X5R 0805 ceramic, total 50µF, Iout=0A to 1.5A) Top trace=Vout, Bottom trace=Iout

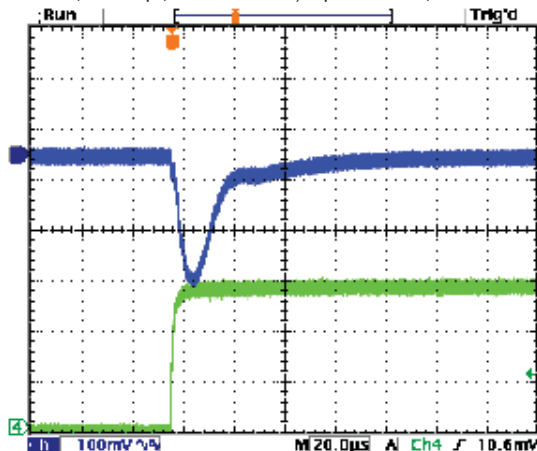

Step Load Transient Response (Vin=12V, Vout=5V, Cload=5x10µF X5R 0805 ceramic, total 50µF, Iout=1.5A to 0A) Top trace=Vout, Bottom trace=Iout

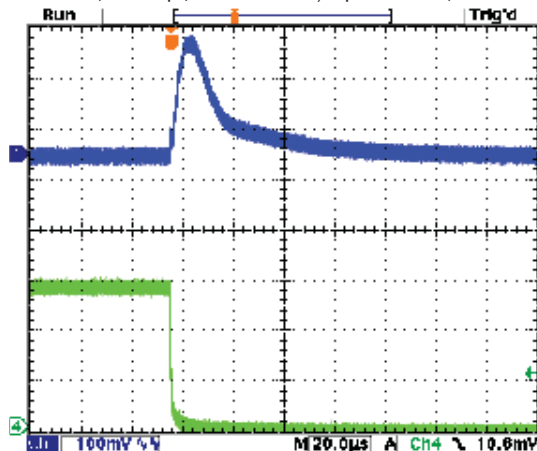

Step Load Transient Response (Vin=7.5V, Vout=5V, Cload=5x10µF X5R 0805 ceramic, total 50µF, Iout=0A to 1.5A) Top trace=Vout, Bottom trace=Iout

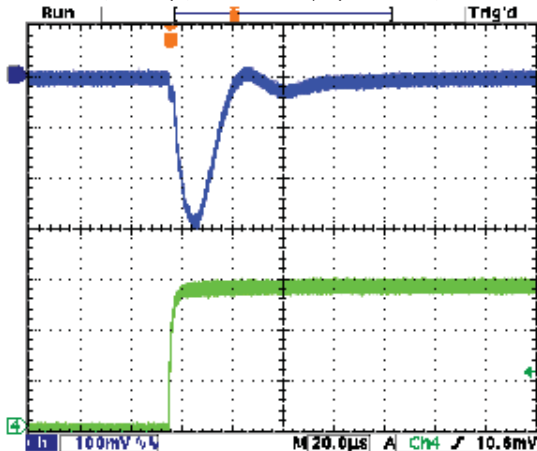

Step Load Transient Response (Vin=7.5V, Vout=5V, Cload=5x10µF X5R 0805 ceramic, total 50µF, Iout=1.5A to 0A) Top trace=Vout, Bottom trace=Iout

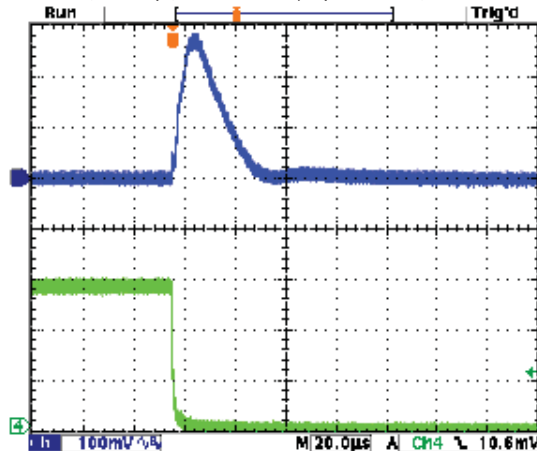

Step Load Transient Response (Vin=12V, Vout=5V, Cload=12x10µF X5R 0805 ceramic, total 120µF, Iout=0A to 1.5A) Top trace=Vout, Bottom trace=Iout

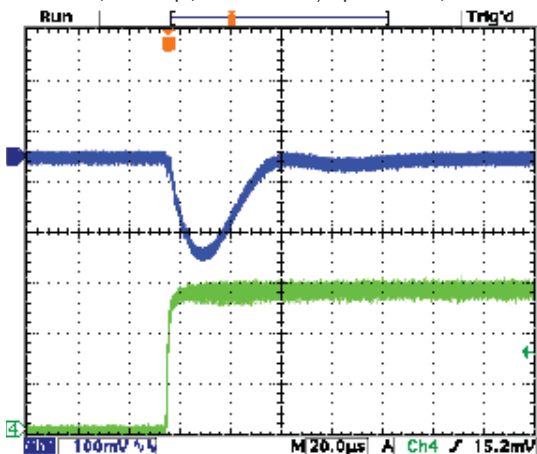

Step Load Transient Response (Vin=12V, Vout=5V, Cload=12x10µF X5R 0805 ceramic, total 120µF, Iout=1.5A to 0A) Top trace=Vout, Bottom trace=Iout

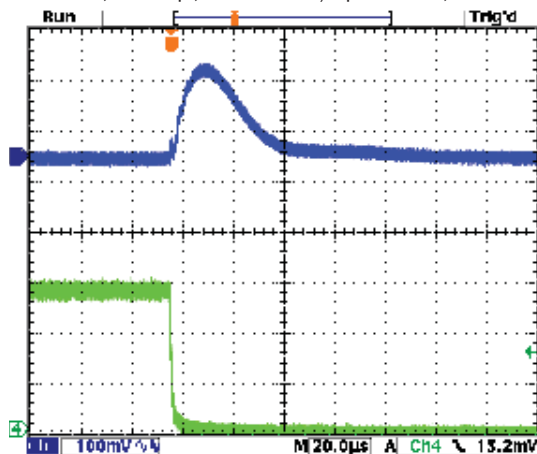

OKR-T/1.5-W12-C OSCILLOGRAMS – Vout = 5V

Step Load Transient Response (Vin=7.5V, Vout=5V, Cload=12x10µF X5R 0805 ceramic, total 120µF, Iout=0A to 1.5A) Top trace=Vout, Bottom trace=Iout

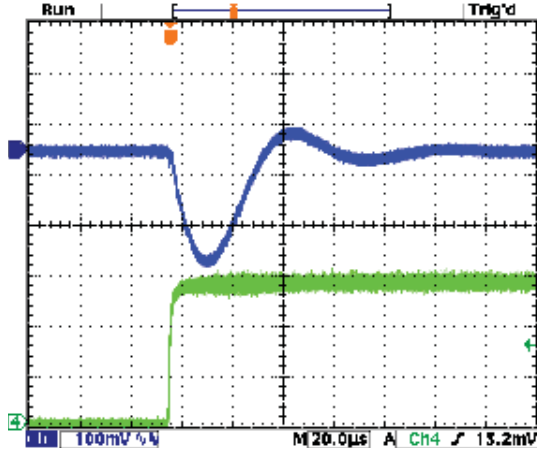

Step Load Transient Response (Vin=7.5V, Vout=5V, Cload=12x10µF X5R 0805 ceramic, total 120µF, Iout=1.5A to 0A) Top trace=Vout, Bottom trace=Iout

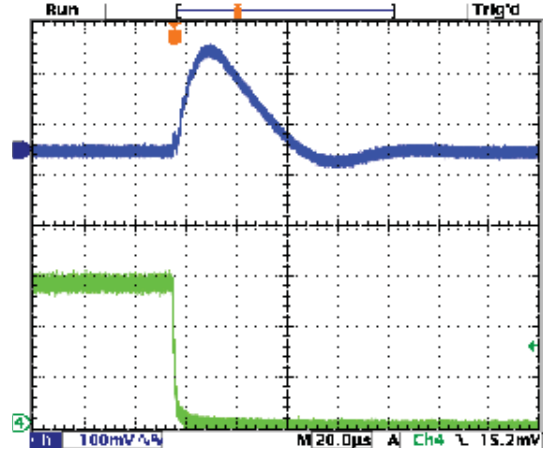

Step Load Transient Response (Vin=7.5V, Vout=5V, Cload=10x10µF X5R 0805 ceramic, plus 1x470µF, 7mΩ POSCAP, total 570µF, Iout=0A to 1.5A) Top trace=Vout, Bottom trace=Iout

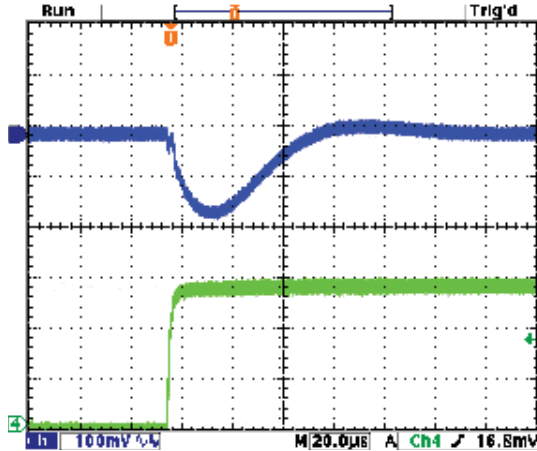

Step Load Transient Response (Vin=7.5V, Vout=5V, Cload=10x10µF X5R 0805 ceramic, plus 1x470µF, 7mΩ POSCAP, total 570µF, Iout=1.5A to 0A) Top trace=Vout, Bottom trace=Iout

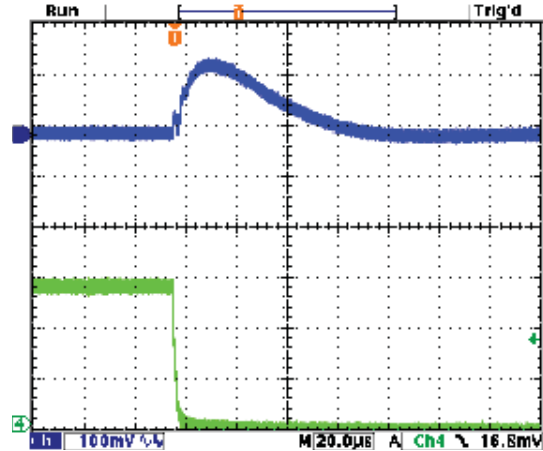

Step Load Transient Response (Vin=12V, Vout=5V, Cload=10x10µF X5R 0805 ceramic, plus 1x470µF, 7mΩ POSCAP, total 570µF, Iout=0A to 1.5A) Top trace=Vout, Bottom trace=Iout

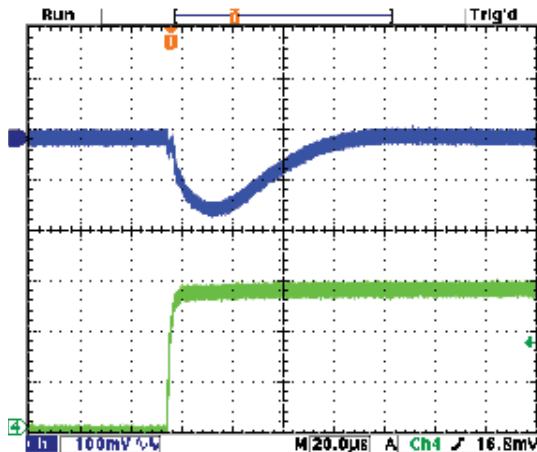

Step Load Transient Response (Vin=12V, Vout=5V, Cload=10x10µF X5R 0805 ceramic, plus 1x470µF, 7mΩ POSCAP, total 570µF, Iout=1.5A to 0A) Top trace=Vout, Bottom trace=Iout

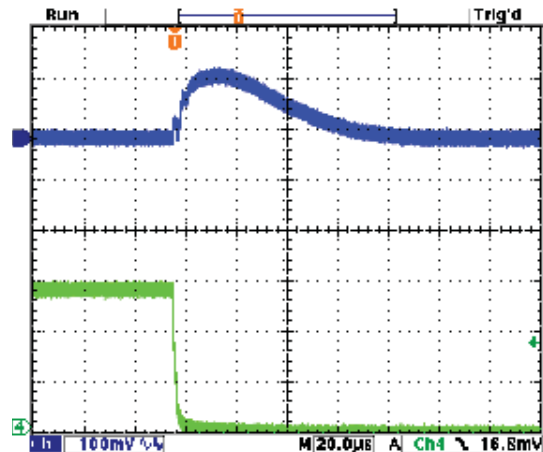

MECHANICAL SPECIFICATIONS

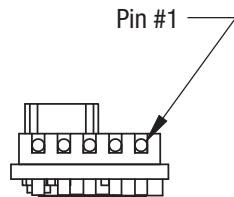
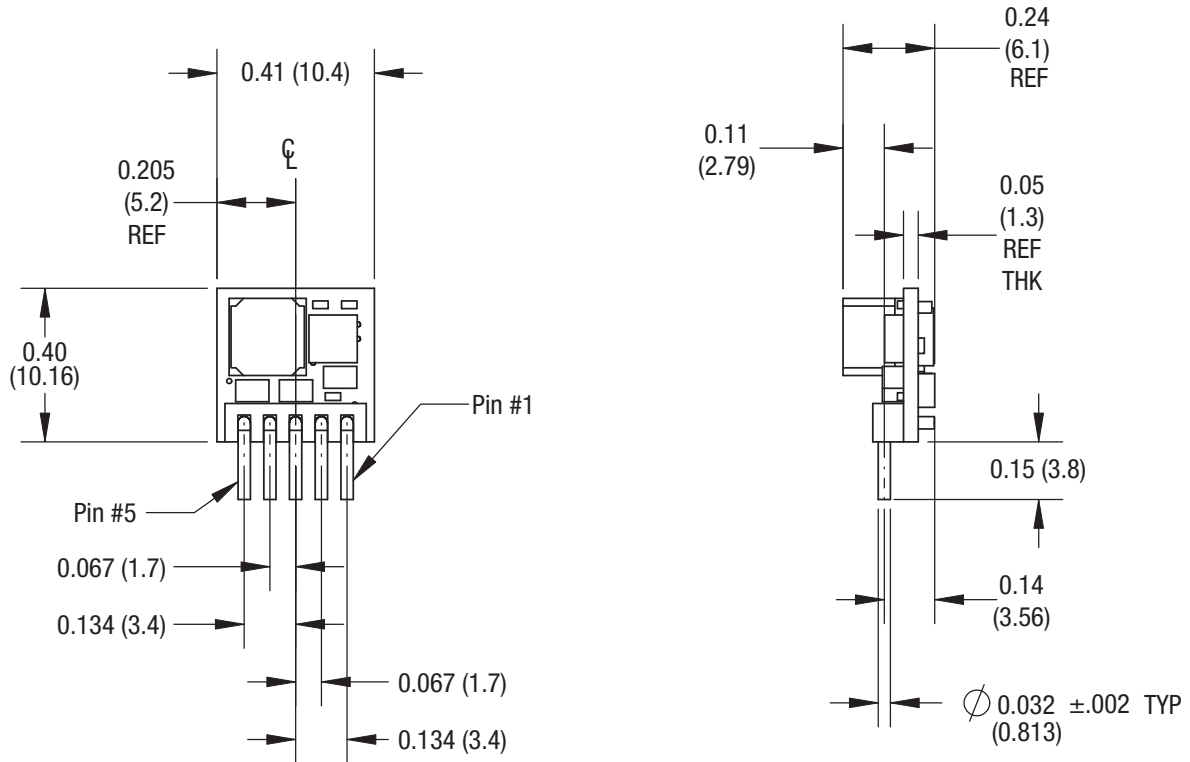

Dimensions are in inches (mm shown for ref. only).

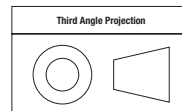

Tolerances (unless otherwise specified):
 .XX ± 0.02 (0.5)
 .XXX ± 0.010 (0.25)
 Angles ± 2°

Components are shown for reference only.

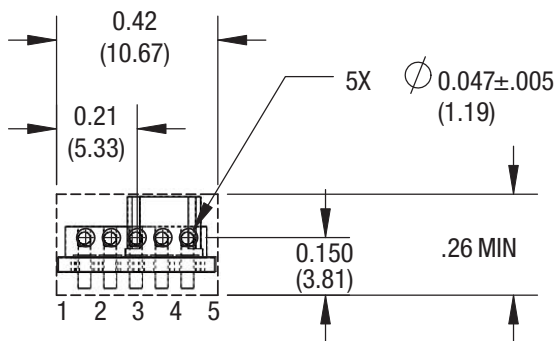
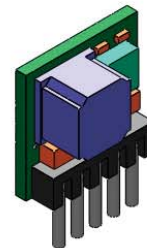

**RECOMMENDED FOOTPRINT
(VIEWED FROM TOP)**

Figure 3. OKR-T/1.5-W12-C
 Component locations are typical.

**INPUT/OUTPUT CONNECTIONS
OKR-T/1.5-W12-C**

Pin	Function
1	Remote On/Off Control*
2	+VIN
3	Ground (Common)
4	+VOUT
5	Trim

* The Remote On/Off can be provided with either positive (P suffix) or negative (N suffix) logic.

STANDARD PACKAGING

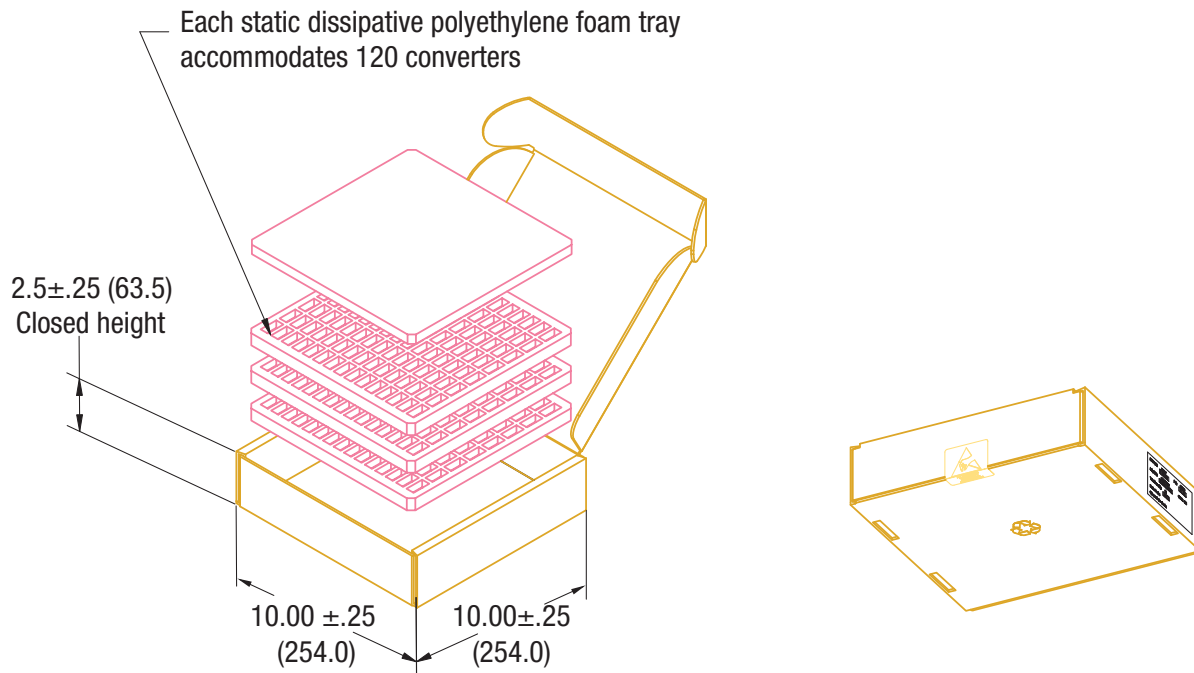

Carton accommodates four (3) trays of 120 yielding 360 converters per carton.

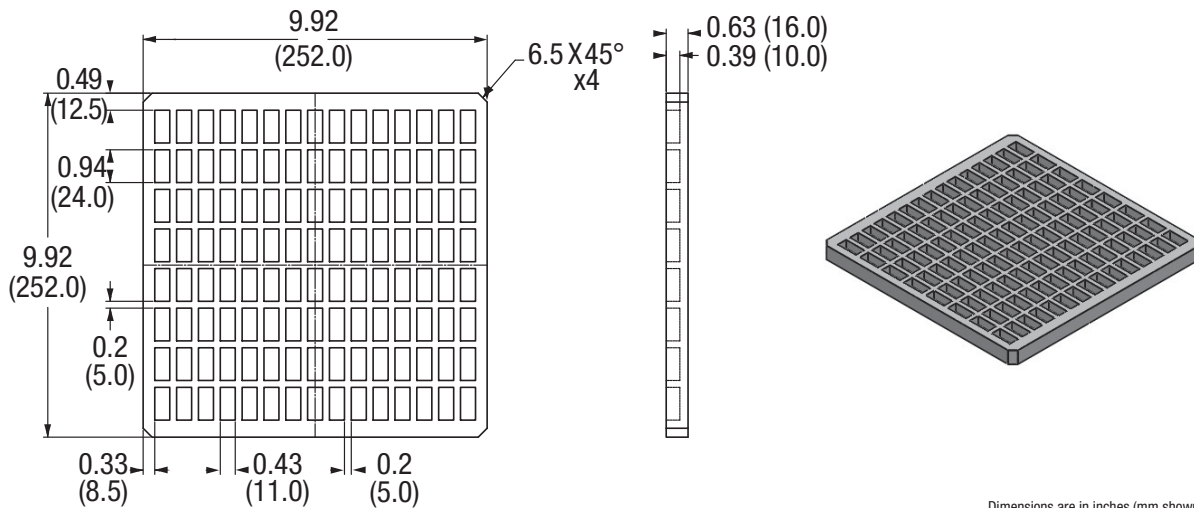

Notes:

1. Material: Dow 220 antistat ethafoam
(Density: 34-35 kg/m³)
2. Dimensions: 252 x 252 x 16 mm
8 x 15 array (120 per tray)

Dimensions are in inches (mm shown for ref. only).

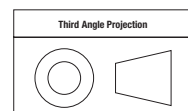

Tolerances (unless otherwise specified):
.XX ± 0.02 (0.5)
.XXX ± 0.010 (0.25)
Angles ± 2°

Components are shown for reference only.

TECHNICAL NOTES

Input Fusing

Certain applications and/or safety agencies may require fuses at the inputs of power conversion components. Fuses should also be used when there is the possibility of sustained input voltage reversal which is not current-limited. For greatest safety, we recommend a fast blow fuse installed in the ungrounded input supply line.

The installer must observe all relevant safety standards and regulations. For safety agency approvals, install the converter in compliance with the end-user safety standard, i.e. IEC/EN/UL 60950-1.

Input Under-Voltage Shutdown and Start-Up Threshold

Under normal start-up conditions, converters will not begin to regulate properly until the ramping-up input voltage exceeds and remains at the Start-Up Threshold Voltage (see Specifications). Once operating, converters will not turn off until the input voltage drops below the Under-Voltage Shutdown Limit. Subsequent restart will not occur until the input voltage rises again above the Start-Up Threshold. This built-in hysteresis prevents any unstable on/off operation at a single input voltage.

Users should be aware however of input sources near the Under-Voltage Shutdown whose voltage decays as input current is consumed (such as capacitor inputs), the converter shuts off and then restarts as the external capacitor recharges. Such situations could oscillate. To prevent this, make sure the operating input voltage is well above the UV Shutdown voltage AT ALL TIMES.

Start-Up Time

Assuming that the output current is set at the rated maximum, the Vin to Vout Start-Up Time (see Specifications) is the time interval between the point when the ramping input voltage crosses the Start-Up Threshold and the fully loaded regulated output voltage enters and remains within its specified accuracy band. Actual measured times will vary with input source impedance, external input capacitance, input voltage slew rate and final value of the input voltage as it appears at the converter.

These converters include a soft start circuit to moderate the duty cycle of its PWM controller at power up, thereby limiting the input inrush current.

The On/Off Remote Control interval from On command to Vout regulated assumes that the converter already has its input voltage stabilized above the Start-Up Threshold before the On command. The interval is measured from the On command until the output enters and remains within its specified accuracy band. The specification assumes that the output is fully loaded at maximum rated current. Similar conditions apply to the On to Vout regulated specification such as external load capacitance and soft start circuitry.

Recommended Input Filtering

The user must assure that the input source has low AC impedance to provide dynamic stability and that the input supply has little or no inductive content, including long distributed wiring to a remote power supply. The converter will operate with no additional external capacitance if these conditions are met.

For best performance, we recommend installing a low-ESR capacitor immediately adjacent to the converter's input terminals. The capacitor should be a ceramic type such as the Murata GRM32 series or a polymer type. Initial

suggested capacitor values are 10 to 22 μF , rated at twice the expected maximum input voltage. Make sure that the input terminals do not go below the undervoltage shutdown voltage at all times. More input bulk capacitance may be added in parallel (either electrolytic or tantalum) if needed.

Recommended Output Filtering

The minimum external output capacitance required for proper operation is 50 μF ceramic type. The maximum external output capacitance is 100 μF ceramic and 470 μF POSCAP. Operating outside of these minimum and maximum limits may affect the performance of the unit.

Input Ripple Current and Output Noise

All models in this converter series are tested and specified for input reflected ripple current and output noise using designated external input/output components, circuits and layout as shown in the figures below. In the figure below, the Cbus and Lbus components simulate a typical DC voltage bus. Please note that the values of Cin, Lbus and Cbus will vary according to the specific converter model.

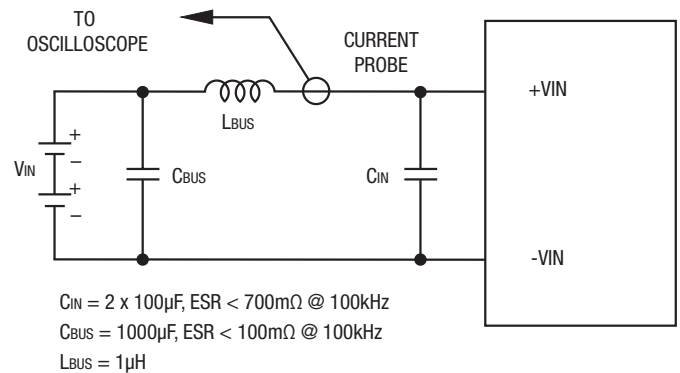

Figure 4. Measuring Input Ripple Current

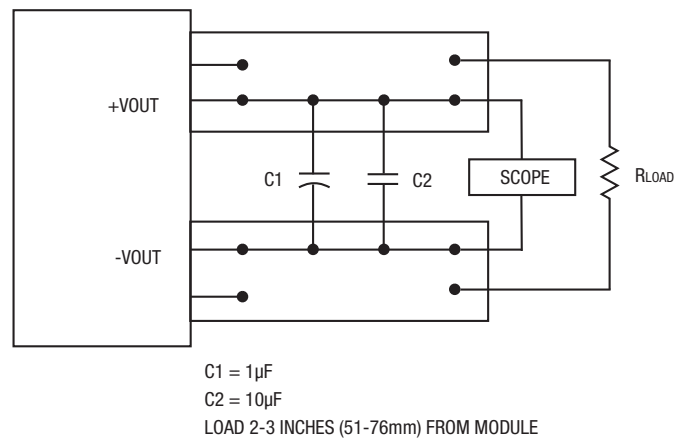

Figure 5. Measuring Output Ripple and Noise (PARD)

Minimum Output Loading Requirements

All models regulate within specification and are stable under no load to full load conditions. Operation under no load might however slightly increase output ripple and noise.

Thermal Shutdown

To prevent many over temperature problems and damage, these converters include thermal shutdown circuitry. If environmental conditions cause the temperature of the DC/DC's to rise above the Operating Temperature Range up to the shutdown temperature, an on-board electronic temperature sensor will power down the unit. When the temperature decreases below the turn-on threshold, the converter will automatically restart. There is a small amount of hysteresis to prevent rapid on/off cycling. The temperature sensor is typically located adjacent to the switching controller, approximately in the center of the unit. See the Performance and Functional Specifications.

CAUTION: If you operate too close to the thermal limits, the converter may shut down suddenly without warning. Be sure to thoroughly test your application to avoid unplanned thermal shutdown.

Temperature Derating Curves

The graphs in this data sheet illustrate typical operation under a variety of conditions. The Derating curves show the maximum continuous ambient air temperature and decreasing maximum output current which is acceptable under increasing forced airflow measured in Linear Feet per Minute ("LFM"). Note that these are AVERAGE measurements. The converter will accept brief increases in current or reduced airflow as long as the average is not exceeded.

Note that the temperatures are of the ambient airflow, not the converter itself which is obviously running at higher temperature than the outside air. Also note that very low flow rates (below about 25 LFM) are similar to "natural convection," that is, not using fan-forced airflow.

Murata Power Solutions makes Characterization measurements in a closed cycle wind tunnel with calibrated airflow. We use both thermocouples and an infrared camera system to observe thermal performance.

CAUTION: If you routinely or accidentally exceed these Derating guidelines, the converter may have an unplanned Over Temperature shut down. Also, these graphs are all collected at slightly above Sea Level altitude. Be sure to reduce the derating for higher density altitude.

Output Current Limiting

Current limiting inception is defined as the point at which full power falls below the rated tolerance. See the Performance/Functional Specifications. Note particularly that the output current may briefly rise above its rated value in normal operation as long as the average output power is not exceeded. This enhances reliability and continued operation of your application. If the output current is too high, the converter will enter the short circuit condition.

Output Short Circuit Condition

When a converter is in current-limit mode, the output voltage will drop as the output current demand increases. If the output voltage drops too low (approximately 98% of nominal output voltage for most models), the magnetically coupled voltage used to develop primary side voltages will also drop, thereby shutting down the PWM controller. Following a time-out period, the PWM will restart, causing the output voltage to begin ramping up to its appropriate value. If the short-circuit condition persists, another shutdown cycle will initiate. This rapid on/off cycling is called "hiccup mode". The hiccup cycling reduces the average output current, thereby preventing excessive internal temperatures and/or component damage. A short circuit can be tolerated indefinitely.

The "hiccup" system differs from older latching short circuit systems because you do not have to power down the converter to make it restart. The system will automatically restore operation as soon as the short circuit condition is removed.

Trim Connections

Output Voltage Adjustment

The output voltage may be adjusted over a limited range by connecting an external trim resistor (Rtrim) between the Trim pin and Ground. The Rtrim resistor must be a 1/10 Watt precision metal film type, ±0.5% accuracy or better with low temperature coefficient, ±100 ppm/oC. or better. Mount the resistor close to the converter with very short leads or use a surface mount trim resistor.

In the tables below, the calculated resistance is given. Do not exceed the specified limits of the output voltage or the converter’s maximum power rating when applying these resistors. Also, avoid high noise at the Trim input. However, to prevent instability, you should never connect any capacitors to Trim.

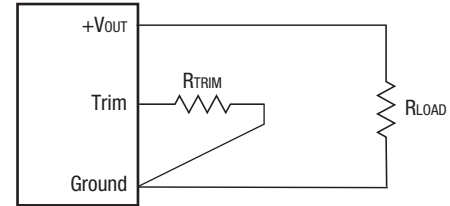

$$R_{TRIM} (k\Omega) = \frac{1.182}{V_{OUT} - 0.591}$$

OKR-T/1.5-W12-C

Output Voltage	Calculated Rtrim (Ω)
6 V.	218.5
5 V.	268
3.3 V.	436
2.5 V.	619
1.8 V.	978
1.5 V.	1300
1.2 V.	1940
1.0 V.	2890
0.591 V.	∞ (open)

Resistor Trim Equation, OKR-T/1.5-W12-C models:

$$R_{TRIM} (k\Omega) = \frac{1.182}{(V_{OUT} - 0.591)}$$

Soldering Guidelines

Murata Power Solutions recommends the specifications below when installing these converters. These specifications vary depending on the solder type. Exceeding these specifications may cause damage to the product. Your production environment may differ; therefore please thoroughly review these guidelines with your process engineers.

Wave Solder Operations for through-hole mounted products (THMT)			
For Sn/Ag/Cu based solders:		For Sn/Pb based solders:	
Maximum Preheat Temperature	115° C.	Maximum Preheat Temperature	105° C.
Maximum Pot Temperature	270° C.	Maximum Pot Temperature	250° C.
Maximum Solder Dwell Time	7 seconds	Maximum Solder Dwell Time	6 seconds

Murata Power Solutions, Inc.
 11 Cabot Boulevard, Mansfield, MA 02048-1151 U.S.A.
 ISO 9001 and 14001 REGISTERED



**This product is subject to the following operating requirements and the Life and Safety Critical Application Sales Policy:
 Refer to: <http://www.murata-ps.com/requirements/>**

Murata Power Solutions, Inc. makes no representation that the use of its products in the circuits described herein, or the use of other technical information contained herein, will not infringe upon existing or future patent rights. The descriptions contained herein do not imply the granting of licenses to make, use, or sell equipment constructed in accordance therewith. Specifications are subject to change without notice. © 2012 Murata Power Solutions, Inc.